

# LOGOPRESS



Die Design Software  
Flattening Software  
Nesting Software  
For **SOLIDWORKS™**



**CERTIFIED**  
Gold  
Product



**DIE DESIGN**

... | BLANK | STRIP LAYOUT | NESTING | ...

Contact us for more information

*I can design small dies using Logopress3 twice as fast as I can using SOLIDWORKS alone. With big dies, the difference isn't quite as high as that, just because there's more thinking involved with big dies."*

**Mike Schmit**  
Oldenburg Metal Tech, Inc.

*Once you've turned that corner from 2D to 3D you'll never go back. I know I never would. I've designed a few dies with Logopress3 so far and I know they went faster than they would have with (2D CAD)."*

**Bill Brunner**  
Strattec Security Corporation

## Logopress

ZA Les Salines  
F-25115 Pouilley les Vignes  
Tel: +33 381 60 23 60  
Fax: +33 381 60 23 69  
Email: [info@logopress3.com](mailto:info@logopress3.com)  
Web: [www.logopress3.com](http://www.logopress3.com)

All Logopress3™ for SOLIDWORKS™ software is Gold Certified by SOLIDWORKS™. More and more die designers all over the world are currently running Logopress3™. Many people who need to create die quotations (via a quick strip layout) and sheet metal part quotations (via a quick blank determination) are also running Logopress3™ or one of its packages.

The work can be started from a SOLIDWORKS™ native part or, more commonly, from an imported part from another cad system. The entire process will be sped up thanks to the dedicated Logopress3™ functions and automation.

Experience the power of over 25 years of continued development.

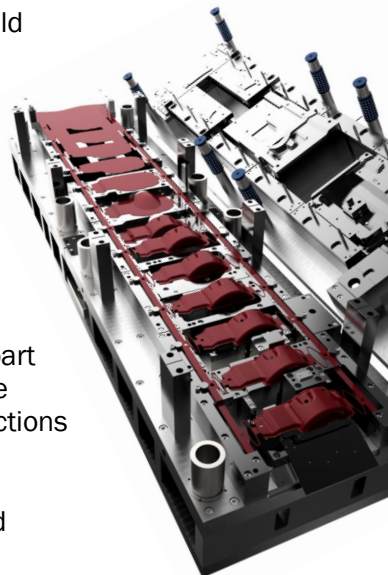

## Logopress Corp. Over 25 years of success

Since 1989 Logopress' only business has been the development of design software for the tool & die industry as well as flattening and blank prediction software for many kinds of parts. Logopress3™ solutions are currently used in over 30 countries around the world.



[www.logopress3.com](http://www.logopress3.com)

[info@logopress3.com](mailto:info@logopress3.com)

Logopress—All rights reserved— 02/2017  
Only for information.

# LOGOPRESS

CERTIFIED  
Gold  
Product

 SOLIDWORKS

**Die Design Software**  
for all types of dies

**DIE DESIGN**

... | UNBENDING FUNCTIONS | ...

Contact us for more information

In only a few mouse clicks you can unfold your part and then model the intermediate stages that will allow defining the process that will become your strip layout. This can be done from a native SOLIDWORKS™ model or from an imported model from any other cad system, without preparing it in any specific way.

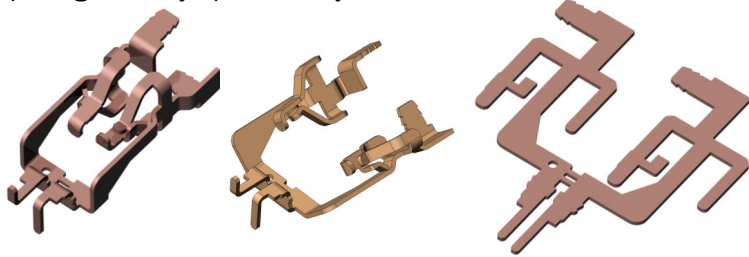

The K-Factors for each individual bend can be automatically calculated by Logopress3™ and the unfolding/unbending features can very easily be edited. This way, you can switch from a full unbending to a partial unbending. You can change the partial unbending angle value, you can manage the spring back options, the bend allowance, etc.

### Highlighted Features:



Gusset

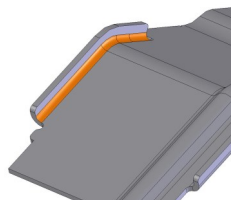

Flange

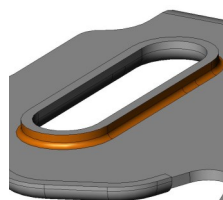

Extruded Hole

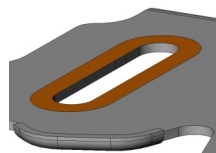
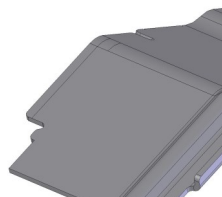
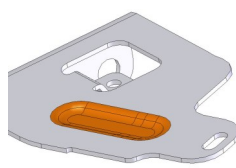

### Unbending

#### Key functions:

- Automatic bend analysis
- Automatic K-Factor calculation for each individual bend
- Customizable and flexible bend allowance management
- Full or partial unbending
- Spring back management
- Overbend management
- Gusset management
- Flange management
- Extruded holes management
- Shearing management
- Non constant thickness management
- Capability to show or hide the previous stages
- Capability to superimpose several intermediate stages

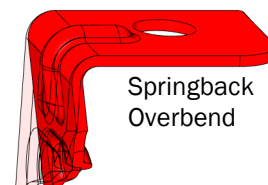

Springback  
Overbend

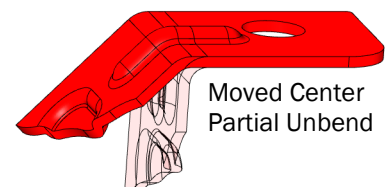

Moved Center  
Partial Unbend

DD2



[www.logopress3.com](http://www.logopress3.com)

[info@logopress3.com](mailto:info@logopress3.com)

Logopress—All rights reserved— 02/2017  
Only for information.

# LOGOPRESS

CERTIFIED  
Gold  
Product

 SOLIDWORKS

Die Design Software  
for all types of dies

**DIE DESIGN**

... | BLANK PREDICTION FUNCTIONS | ...

Contact us for more information

Logopress3™ BLANK allows the user to quickly and easily determine the theoretical blank of 3D complex shaped parts. The parts can be imported solid or surface models that have come from a different CAD system.

The Flattening function helps both at the quotation stage and in the die design process. It minimizes development time in the press. The mesh is fully automatic but its size can also be adjusted if the user wishes to do so.

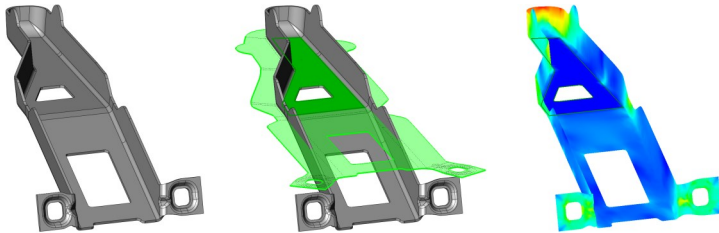

There is no need to be a mechanical engineer with finite element analysis skills to handle the Logopress3™ BLANK module because it is very user friendly.

The Logopress3™ BLANK module is included inside the die design package but can also be purchased independently if you don't need to design strip layouts and complete dies.

Logopress3F is the package that includes both Logopress3™ BLANK capabilities and Logopress3™ Unbending capabilities (including multi-stage unbending management too).

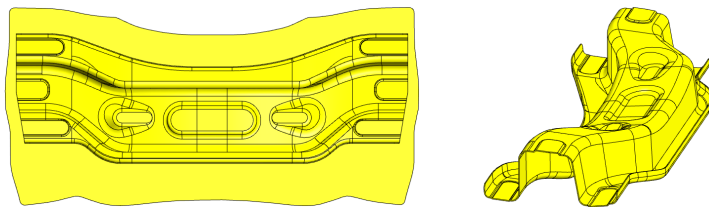

## Blank Prediction

### Key functions:

- Manage native and/or imported data
- Manage solids and surfaces
- Material thickness management
- Customizable material database
- Choice of the “stamping starting area”
- Choice of the “stamping direction”
- Allow defining pinched/locked areas
- Thinning and thickening information
- Stress and strain information

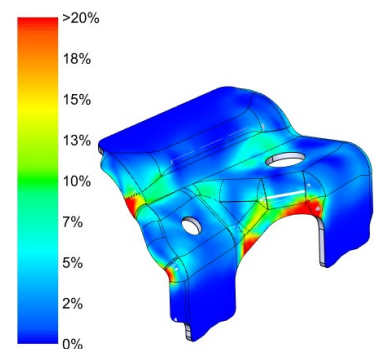

DD3



[www.logopress3.com](http://www.logopress3.com)

[info@logopress3.com](mailto:info@logopress3.com)

Logopress—All rights reserved— 02/2017  
Only for information.



# LOGOPRESS

CERTIFIED  
Gold  
Product

 SOLIDWORKS

**Die Design Software**  
for all types of dies

**DIE DESIGN**

... | STRIP LAYOUT FUNCTIONS | ...

Contact us for more information

The strip layout module can be used for both progressive dies and transfer dies. It allows quick modeling of the true solid 3D strip in a very easy and logical way, resulting from our 25 years experience shared with passionate die designers.

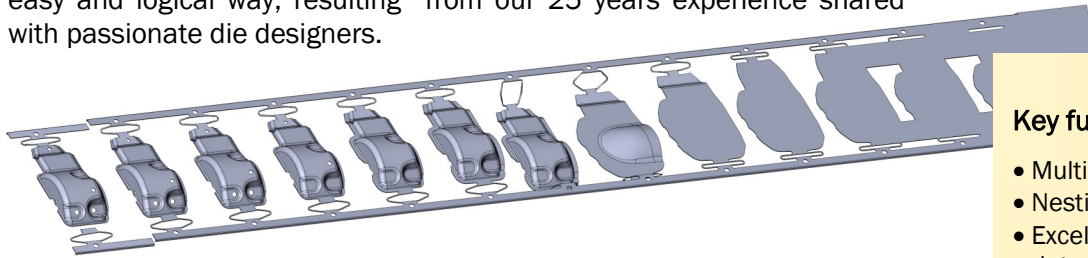

The Logopress3™ strip module can be started from a blank and a folding/stamping process that was first defined using the Logopress3™ Unbending and Flattening tools or from dumb imported data provided by your customers or partners.

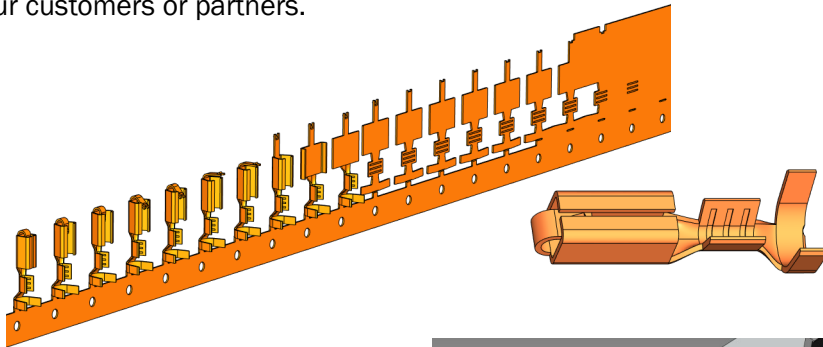

Any kind of parts, even those with non-constant thickness or coining are able to be managed. It also allows managing multiple parts in one strip, whether they be identical, mirrored or completely different.

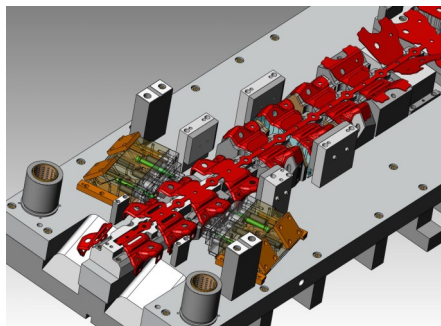

## Strip Layout

### Key functions:

- Multiple part management
- Nesting optimization
- Excel spreadsheet including useful data for quoting
- Drag and drop actions
- Mismatch wizard
- Insert/delete stations
- Material usage info
- Force info
- Global center of force computation
- Local center of force computation
- Spring back management
- Capability to show or hide the previous stages
- Associativity with the Unbending/Flattening process
- OpenGL preview
- Automatic creation of internal punches
- Powerful assistant tool to define cutting punches in the skeleton
- Powerful assistant tool to define bending and forming punches
- Punch patterning

DD4

SINCE 1989  
  
LOGOPRESS

[www.logopress3.com](http://www.logopress3.com)

[info@logopress3.com](mailto:info@logopress3.com)

Logopress—All rights reserved— 02/2017  
Only for information.

# LOGOPRESS

CERTIFIED  
Gold  
Product

 SOLIDWORKS

**Die Design Software**  
for all types of dies

**DIE DESIGN**

... | ROUND DRAW FUNCTIONS | ...

Contact us for more information

Logopress3™ strip layout module also includes great and specific features and capabilities dedicated to Round Draw Parts.

For those who have to manage these kinds of parts, this may mean saving several hours of work or even several days! Take a look at the pictures below. They speak more than a long explanation would, knowing that all of this is done in less than 5 minutes!

It's also important to highlight that as everything is parametric, any changes can be done very quickly. In addition to that, you will find it very interesting to note that this is not newly developed technology, but rather has been well proven for over 20 years in our previous Logopress2 2D product as well.

10 seconds for this:



Plus 2 minutes for this:

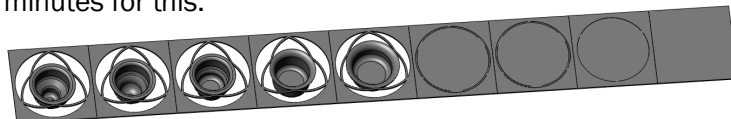

Plus 30 seconds for this:

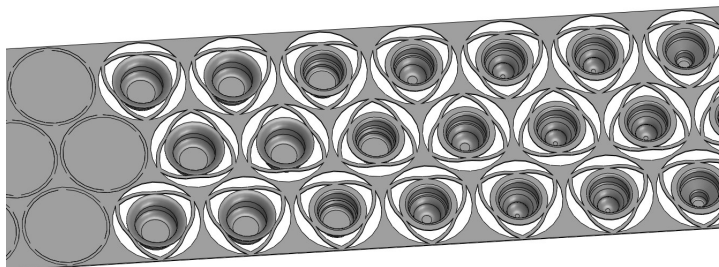

## Round Draw

### Key functions:

- Automatic computation of each intermediate stage
- Material type of drawn part automatically determines what draw reductions are used
- Draw reductions can be manually edited for each individual station
- Customizable computation database to include your experience and know how
- Automatic re-computation when changing a radius or a diameter
- Stripper pressure computation
- Automatic and customizable web management
- Graphical overlays of previous stations or subsequent stations

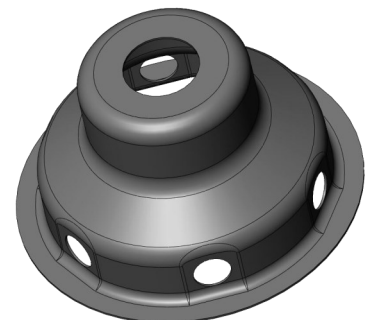

DD5



[www.logopress3.com](http://www.logopress3.com)

[info@logopress3.com](mailto:info@logopress3.com)

Logopress—All rights reserved— 02/2017  
Only for information.

# LOGOPRESS

CERTIFIED  
Gold  
Product

 SOLIDWORKS

**Die Design Software**  
for all types of dies

**DIE DESIGN**

... | NESTING FUNCTIONS | ...

Contact us for more information

Logopress3™ NESTING starts with either a multi-body part file (created with SOLIDWORKS or imported from a different CAD system) or with individual part files that are in an assembly. After setting some logical parameters that allow extreme flexibility it will quickly nest the parts per the options that you set.

For a die designer, this module is for example very useful when building Wire EDM burn blocks or for nesting various shaped sharpening shims for under die inserts.

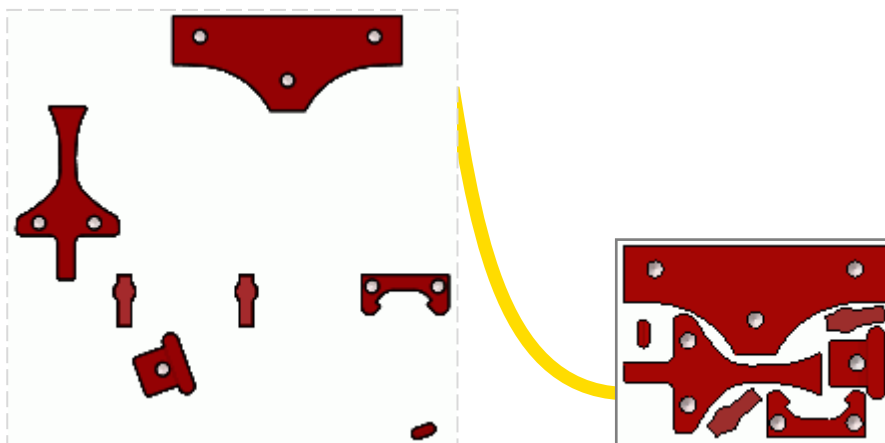

## Nesting

### Key functions:

- Multiple nesting options and strategies included
- Supports either multibody parts or parts within an assembly
- Set sheet size to nest on or set only width
- Angular control of parts
- Option to nest into openings or not to
- Option to allow parts to flip upside down
- Flexibility in setting clearances between parts
- Ability to set quantities for each individual part
- Automatic report generation

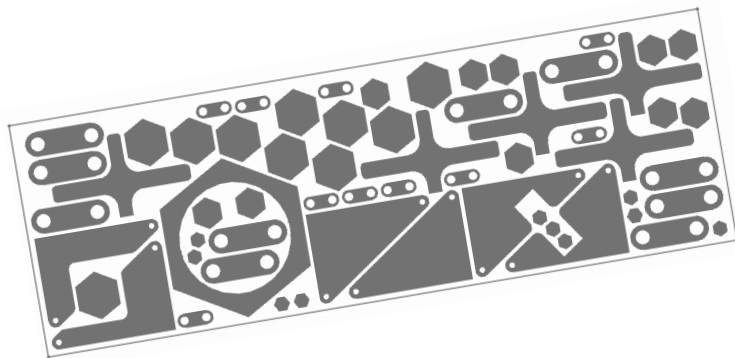

DD6



[www.logopress3.com](http://www.logopress3.com)

[info@logopress3.com](mailto:info@logopress3.com)

Logopress—All rights reserved— 02/2017  
Only for information.



# LOGOPRESS

CERTIFIED  
Gold  
Product

 SOLIDWORKS

**Die Design Software**  
for all types of dies

**DIE DESIGN**

... | DIE SET ASSISTANT & STANDARD COMPONENTS | ...

**Contact us for more information**

Logopress3™ Die Design Software includes a powerful **Tool Structure Assistant** that allows you to quickly model the main die components. It is also very useful throughout the entire die design process when you need to insert additional plates or sub-assemblies.

You can very easily and very quickly insert a plate or a sub-assembly and then adjust its dimensions. The plates can be named at this point and material type and heat treatment can also be specified at the time of insertion. It also acts as a Mate Manager so that you don't have to search the feature tree for mates.

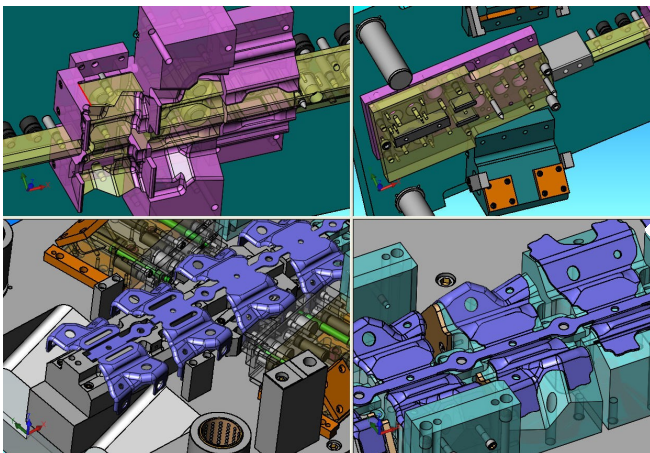

No die design software is complete unless it has a thorough **Intelligent Standard Component Library**. The Logopress3™ library not only inserts the component you select but also cuts every hole in each plate and automatically manages all mates.

It manages both millimeter and inch components and includes literally dozens of vendors that you are also able to add to. The only way to understand how powerful, user friendly, flexible, customizable, strong and complete it is, you must see it for yourself.

### Tool Structure Assistant

#### Key functions:

- Component and sub-assembly insertion feature dedicated to the die design needs
- Customizable plates
- Customizable die sets
- Automatic mate management
- Customizable material database
- Customizable heat treat callouts

### Intelligent Standard Component Library

#### Key functions:

- Holes are cut and components inserted with one mouse validation click
- Standard Hole Wizard holes
- Automatically sizing of components
- Choice assistant
- Automatic patterning
- Edit definition
- Smart copy and paste function
- Customizable library
- Automatic mate management
- Automatic hole creation
- OpenGL preview
- Wire EDM hole management
- Dozens of custom and multi stepped holes—all hole chartable
- User defined custom components

DD7



[www.logopress3.com](http://www.logopress3.com)

[info@logopress3.com](mailto:info@logopress3.com)

Logopress—All rights reserved— 02/2017  
Only for information.

# LOGOPRESS

CERTIFIED  
Gold  
Product

 SOLIDWORKS

Die Design Software  
for all types of dies

DIE DESIGN

... | PUNCH & INSERT ASSISTANT | ...

Contact us for more information

Logopress3™ also includes powerful features to “Mount” the cutting, bending and forming punches (cut all openings in all plates). **Punch Mounting** would be a huge amount of work without this dedicated feature since so many die components are involved with each needing different clearances. Logopress3™ easily manages this with only a few mouse clicks and dialog box settings. After you define the first one, Logopress3™ stores your preferences in order to save even more time for the next mounting.

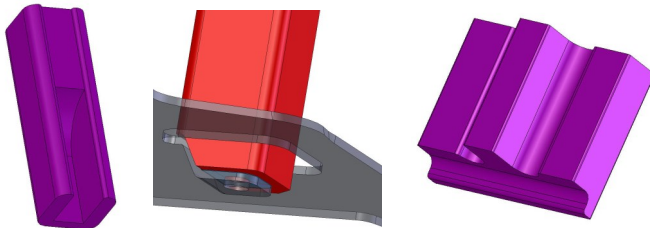

If later on you decide to create an **insert** around your punch or die mounting, Logopress3™ offers you a dedicated feature to do this very easily, including the ability to automatically create a shim under the insert.

The “Add an insert” command adds an insert (and a shim if desired) in less than 5 min.

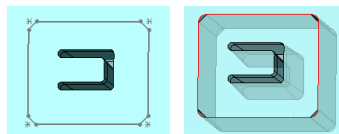

## Punch Mounting

### Key functions:

- Cutting punches
- Automatic plate recognition
- Bending punches
- Coining management
- Forming punches
- Cut all openings in all plates
- Clearance management
- Relief type management (tapered or stepped relief)
- Shoulder, heel, pedestal and roof management
- Locking tab management
- Editable mountings
- Store user defined preferences
- Punch mismatches/undercuts
- Corner relief options

DD8



[www.logopress3.com](http://www.logopress3.com)

[info@logopress3.com](mailto:info@logopress3.com)

Logopress—All rights reserved— 02/2017  
Only for information.



# LOGOPRESS



CERTIFIED  
Gold  
Product

 SOLIDWORKS

**Die Design Software**  
for all types of dies

**DIE DESIGN**

... | DIE SIMULATION, INTERFERENCE DETECTION | ...

Contact us for more information

In addition to all of these tools & features designed to increase your productivity, Logopress3™ Die Design also includes a **Die Simulation** command along with a **Dynamic Interference Detection**. This command provides far more than just a visual animation and assures that mistakes are caught at the design stage and not at the much more expensive and time consuming build stage of the die.

It can simulate not only progressive dies, but also transfer dies, fineblank dies and also fourslide and multislide machines. In addition to conventional presses, users can accurately simulate motion curves for servo presses and link motion presses. Varying progression (as occurs in a transfer die) and varying lift can also be simulated, along with part rotation. Motion can follow predefined paths, for example, transfer systems and the part falling off the end of the die. Interference is checked through the entire tool as the parts of the tool are moving exactly as they would in the press.

### Die Simulation Dynamic Interference Detection

#### Key functions:

- Can simulate dies designed with or without Logopress3 & SolidWorks
- Almost no setup required for a progressive die designed with Logopress3. Just press the icon and set your press stroke, stripper travel and strip lift
- Detects collision during the press cycle, including strip lift & advance
- Highly visual and accurate representation of the die running in the press
- Finds clearance issues before the die goes in the press

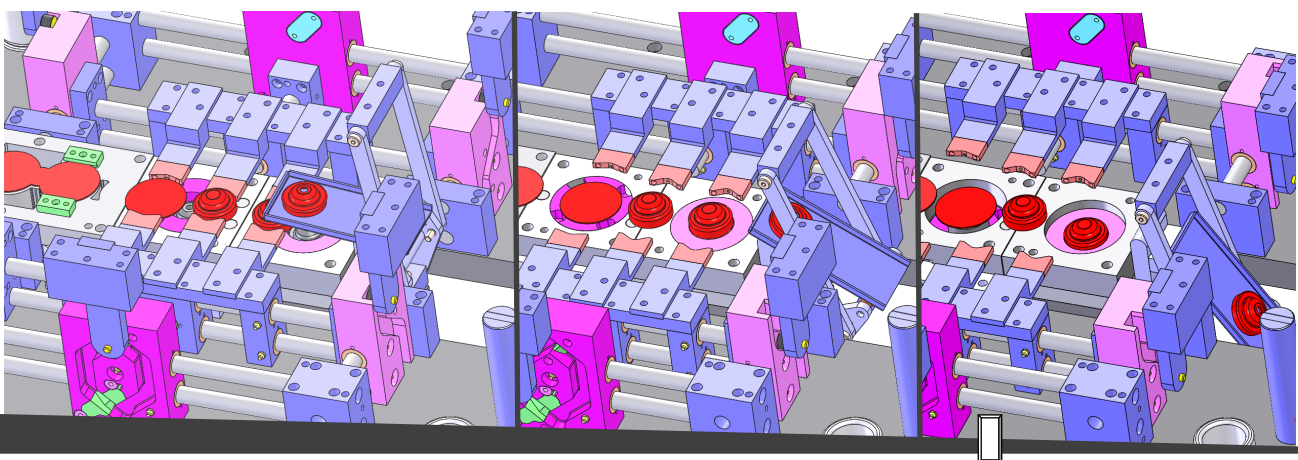

DD9

SINCE 1989  
  
LOGOPRESS

[www.logopress3.com](http://www.logopress3.com)

[info@logopress3.com](mailto:info@logopress3.com)

Logopress—All rights reserved— 02/2017  
Only for information.

# LOGOPRESS3

CERTIFIED  
Gold  
Product

SOLIDWORKS

Die Design Software  
for all types of dies

DIE DESIGN

... | 2D DRAWINGS, HOLE CHART & BOM | ...

Contact us for more information

Logopress3™ has multiple tools for automatically creating the 2D drawings for the 3D model, including automatic population of title blocks. These tools enhance the tools already in SOLIDWORKS™ and include a specific and powerful **Logopress3™ Hole Chart Feature** as well as a specific and customizable **Logopress3™ BOM**. The **Logopress3™ Smart Ordinate Dimensioning** command makes dimensioning extremely fast.

SOLIDWORKS™ along with Logopress3™ make the creation of detail drawings very easy and fast, with considerable flexibility allowed for user preferences.

Hole Tag	X	Y	Top Hollow	Bottom Hollow	Designation	Standard Components
1	45	45			Ø45 Thru All	
2	45	255			Ø45 Thru All	Press Fit Guide Post DANLY METRIC Ref: 5
3	355	255			Ø45 Thru All	Self Lubricating Demountable Short DANLY METRIC Ref: 6-3249
4	358	45			Ø45 Thru All	
5	45	287.5			Ø6.75 228bottom MBl: 25 18bottom	
6	148.5	238.75			Ø6.75 228bottom MBl: 25 18bottom	
7	73.15	238.75			Ø6.75 228bottom MBl: 25 18bottom	
8	355	287.5			Ø6.75 228bottom MBl: 25 18bottom	
9	326.85	238.75			Ø6.75 228bottom MBl: 25 18bottom	
10	383.15	238.75			Ø6.75 228bottom MBl: 25 18bottom	
11	386.15	61.25			Ø6.75 228bottom MBl: 25 18bottom	Press Fit Guide Post DANLY METRIC Ref: 5
12	329.85	61.25			Ø6.75 228bottom MBl: 25 18bottom	
13	358	12.5			Ø6.75 228bottom MBl: 25 18bottom	
14	73.15	61.25			Ø6.75 228bottom MBl: 25 18bottom	

### Tool & Die Hole Charts

#### Key functions:

- Front side and back side holes in the same chart
- Automatic, compact or complete and very detailed description of every hole in addition to the X and Y data for each tag, tolerances and also the standard component going into that hole

### BOM (Bill of Materials)

#### Key functions:

- Many options for automatic sorting/sequencing of balloons
- Populates sizes of without needing reference dimensions
- Automatically sort/group upper, middle & lower parts as well as standard components

Logopress3™ takes full advantage of all of SOLIDWORKS™ power and ease of use and includes many other dedicated tools based on our 25 years of experience that will make today's modern die designers much more productive. In the end, you will be much more profitable.

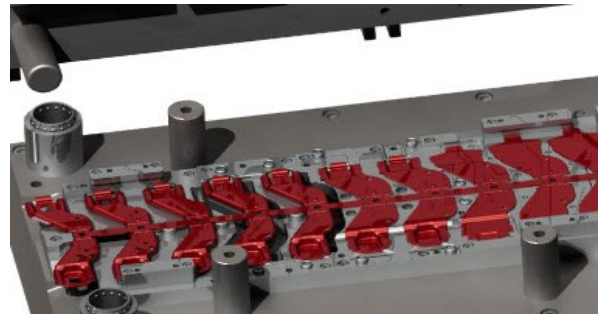
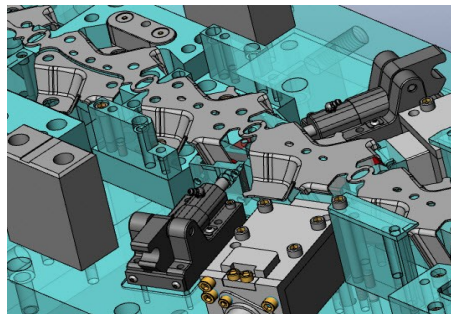

DD10



www.logopress3.com

info@logopress3.com

Logopress—All rights reserved— 02/2017  
Only for information.

# LOGOPRESS

CERTIFIED  
Gold  
Product

 SOLIDWORKS

Die Design Software  
for all types of dies

**DIE DESIGN**

... | PROGRESSIVE BLANK COMPANION **OPTION** | ...

Contact us for more information

Progressive Blank Companion is a greatly anticipated and requested add-on that was released at the beginning of 2012. It allows die designers to model the complex-shaped intermediate stages of a progressively formed part in minutes instead of hours or days.

Behind its user-friendly interface, this powerful add-on is made up of complex mathematical algorithms and is the result of several years of research and development invested by Logopress.

Besides simplifying and speeding up the modeling of intermediate stages, Progressive Blank Companion also provides localized information about thinning and thickening as well as measuring stress and strain.

Progressive Blank Companion also allows the user to form a flat BLANK up to a complex shaped surface.

Progressive Blank Companion can be added on to any of the following Logopress3 software packages: BLANK, FLATTENING, STRIP LAYOUT or DIE DESIGN.

Progressive Blank Companion is an optional add-on that requires one of the Logopress3 software packages listed below:

- BLANK
- FLATTENING
- STRIP LAYOUT
- DIE DESIGN

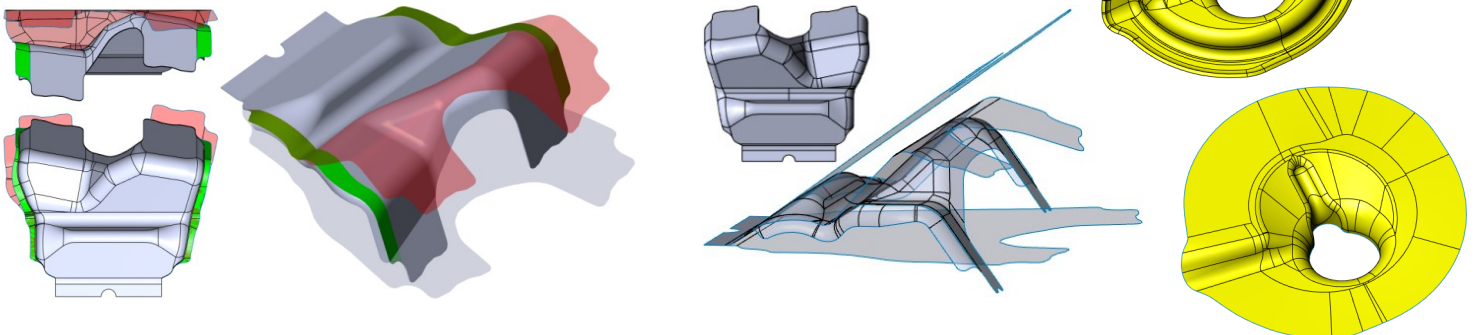
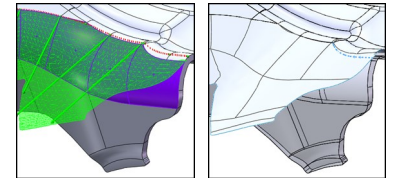

See narrated video demonstrations at: [www.DieDesignSoftware.com/videos/pbc-videos](http://www.DieDesignSoftware.com/videos/pbc-videos)

PBC1



[www.logopress3.com](http://www.logopress3.com)

[info@logopress3.com](mailto:info@logopress3.com)

Logopress—All rights reserved— 02/2017  
Only for information.



# LOGOPRESS

CERTIFIED  
Gold  
Product

 SOLIDWORKS

Die Design Software  
for all types of dies

**DIE DESIGN**

... | PROGRESSIVE BLANK COMPANION OPTION | ...

Contact us for more information

Model the complex-shaped intermediate stages of a progressively formed part in **minutes** instead of hours or days.

### Highlighted Features:

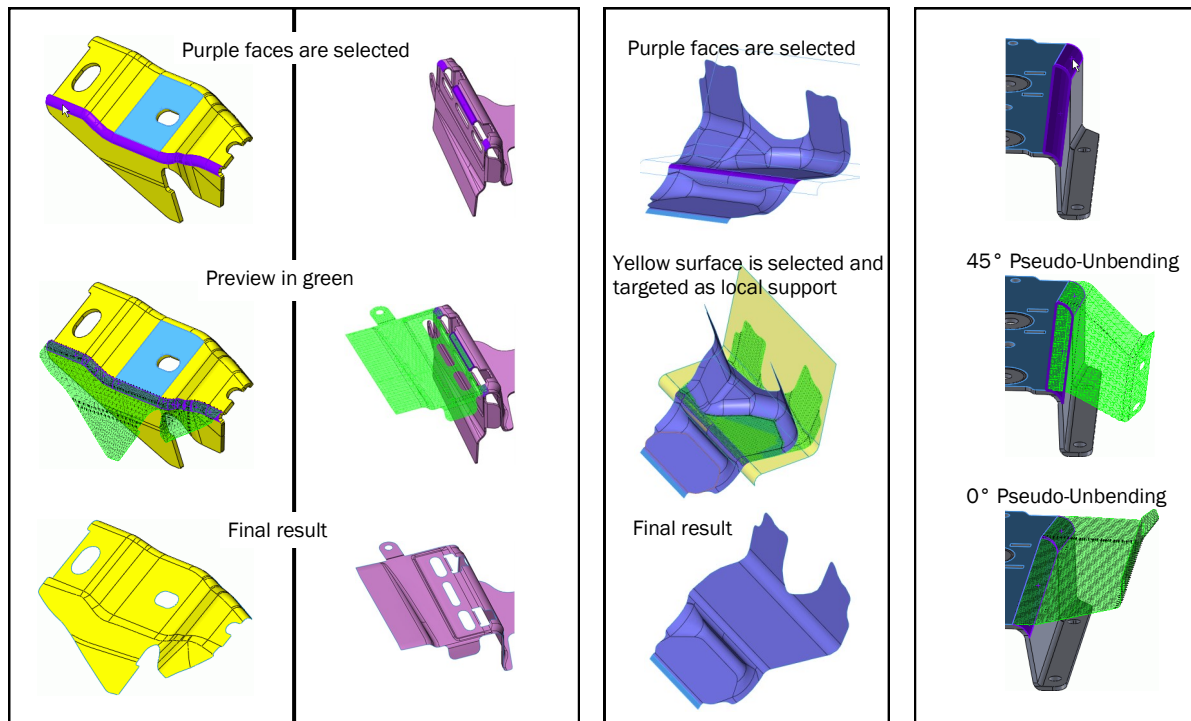

See narrated video demonstrations at: [www.DieDesignSoftware.com/videos/pbc-videos](http://www.DieDesignSoftware.com/videos/pbc-videos)

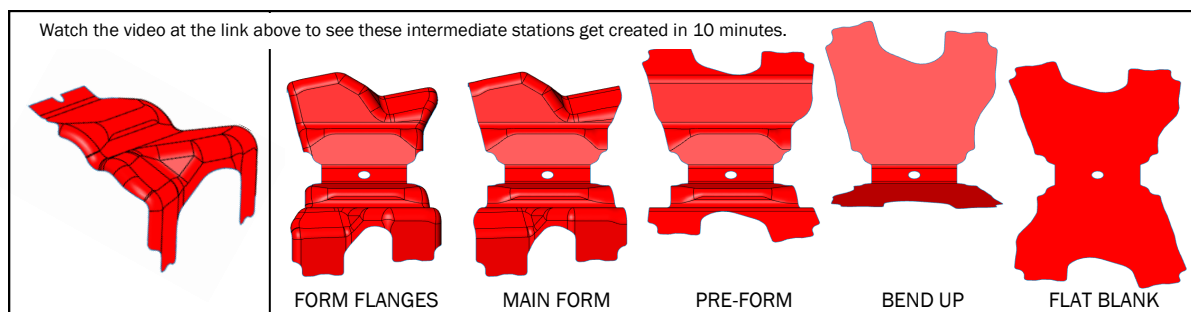

PBC2



[www.logopress3.com](http://www.logopress3.com)

[info@logopress3.com](mailto:info@logopress3.com)

Logopress—All rights reserved— 02/2017  
Only for information.